

program:

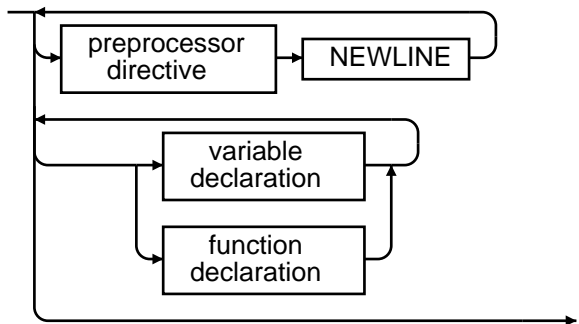

preprocessor-directive:

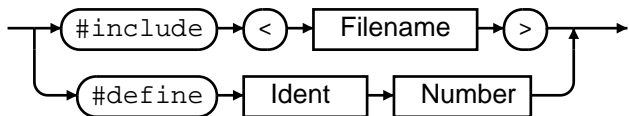

variable-declaration:

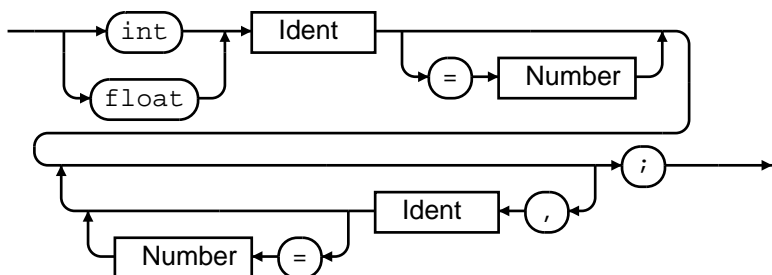

function-declaration:

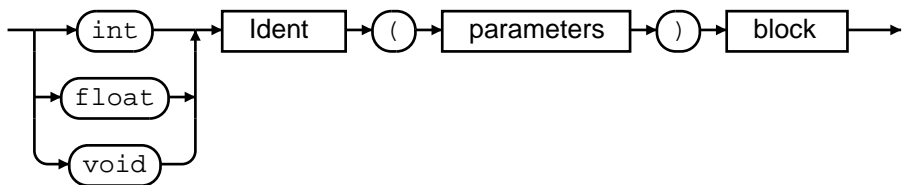

parameters:

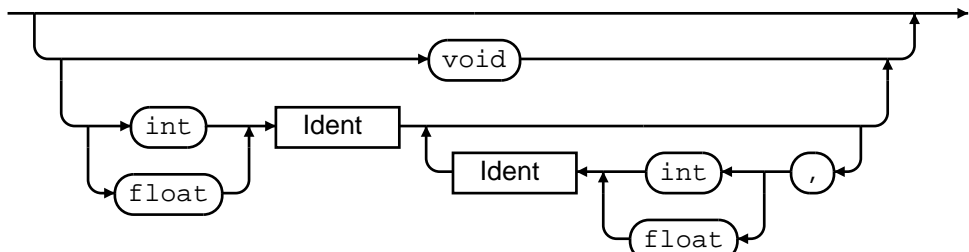

block:

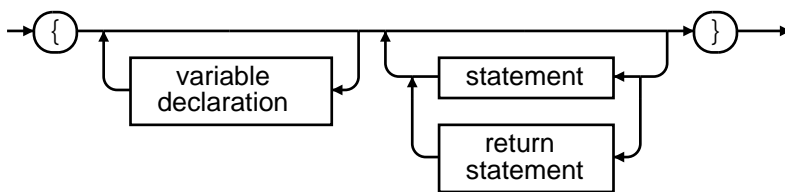

statement:

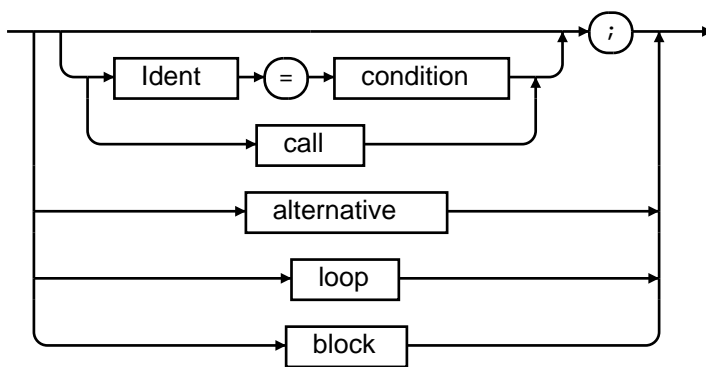

return-statement:

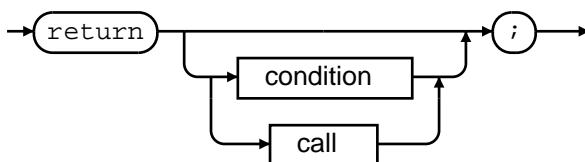

call:

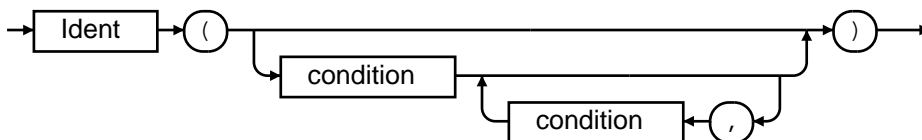

alternative:

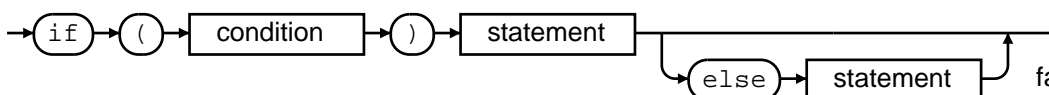

loop:

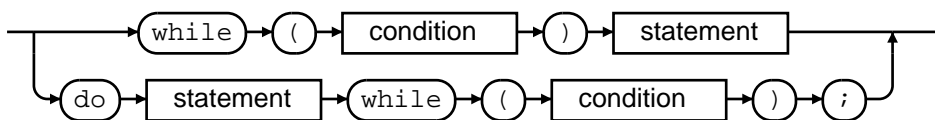

condition:

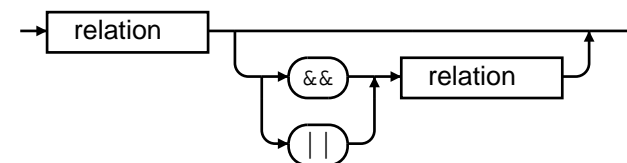

relation:

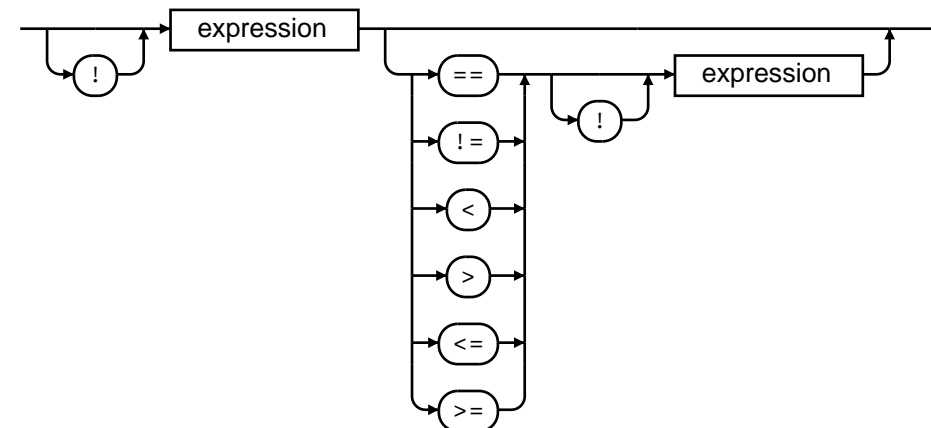

expression:

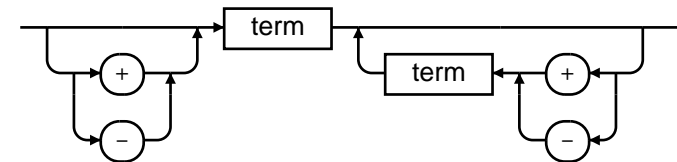

term:

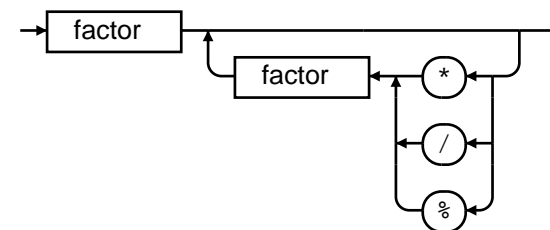

factor:

